



DEP706 - Design Exploration Seminar

Forming LED

Submitted By

Santosh Kumar Sagar 196130008

M.Des (*Industrial Design*)

Guide

Prof. Avinash Shende

IDC School of Design
अभिकल्प विद्यालय

Introduction

The project began with working on the background research on understanding the LED technology and generating concepts for the exploration simultaneously.

Concepts are derived from the nature around us by taking inspirations from the surroundings, looking with a poetic eye and philosophical mindset while opposing a programmed practical perspective during the observation stage.

Meanwhile, background research on LEDs is done to understand the technology involved in working and knowing the available tech's specifications at footstep to determine the most suitable type for the concept generated.

Further research is done on color theories to know the emotional aspect of the lights on users. Few exciting works of designers/artists are also studied to learn the ways light has been explored till now on the field.

All the findings from the research are used to develop the final concept with forming LEDs.

Introduction

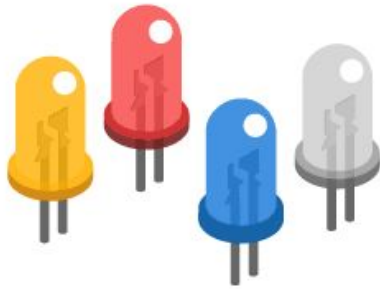

Image 01: Typical Light emitting diode

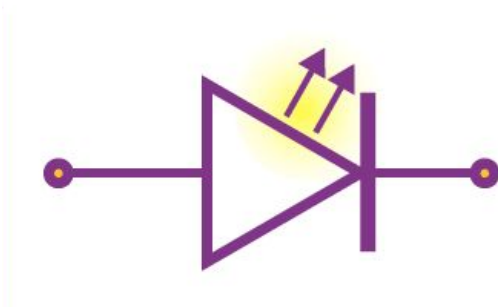

Image 02: LED symbol

LED - light-emitting diode (LED)

In the simplest terms, a light-emitting diode (LED) is a semiconductor device that emits light when an electric current is passed through it. Light is produced when the particles that carry the current (known as electrons and holes) combine together within the semiconductor material. Since light is generated within the solid semiconductor material, LEDs are described as solid-state devices. The term solid-state lighting, which also encompasses organic LEDs (OLEDs), distinguishes this lighting technology from other sources that use heated filaments (incandescent and tungsten halogen lamps) or gas discharge (fluorescent lamps).

Working of LED

LEDs are basically just a specialised type of diode as they have very similar electrical characteristics to a PN junction diode. The holes lie in the valence band, while the free electrons are in the conduction band. When there is a forward bias in the p-n junction, the electron, which is a part of the n-type semiconductor material, would overrun the p-n junction and join with the holes in the p-type semiconductor material.

Introduction

The figure demonstrates the elementary process principle.

When this movement of free electrons and holes takes place, there is a change in the energy level as the voltage drops from the conduction band to the valance band. There is a release of energy due to the motion of the electron. In standard diodes, the release of energy in the manner of heat. But in LED, the release of energy in the form of photons would emit light energy. The entire process is known as electroluminescence, and the diodes are known as a light-emitting diode.

In LED, energy discharged in light form hinges on the forbidden energy gap. One could manipulate the wavelength of the light produced. Therefore, from its wavelength, the light color and its visibility can be controlled. The color and wavelength of the light emitted can be determined by doping it with several impurities.

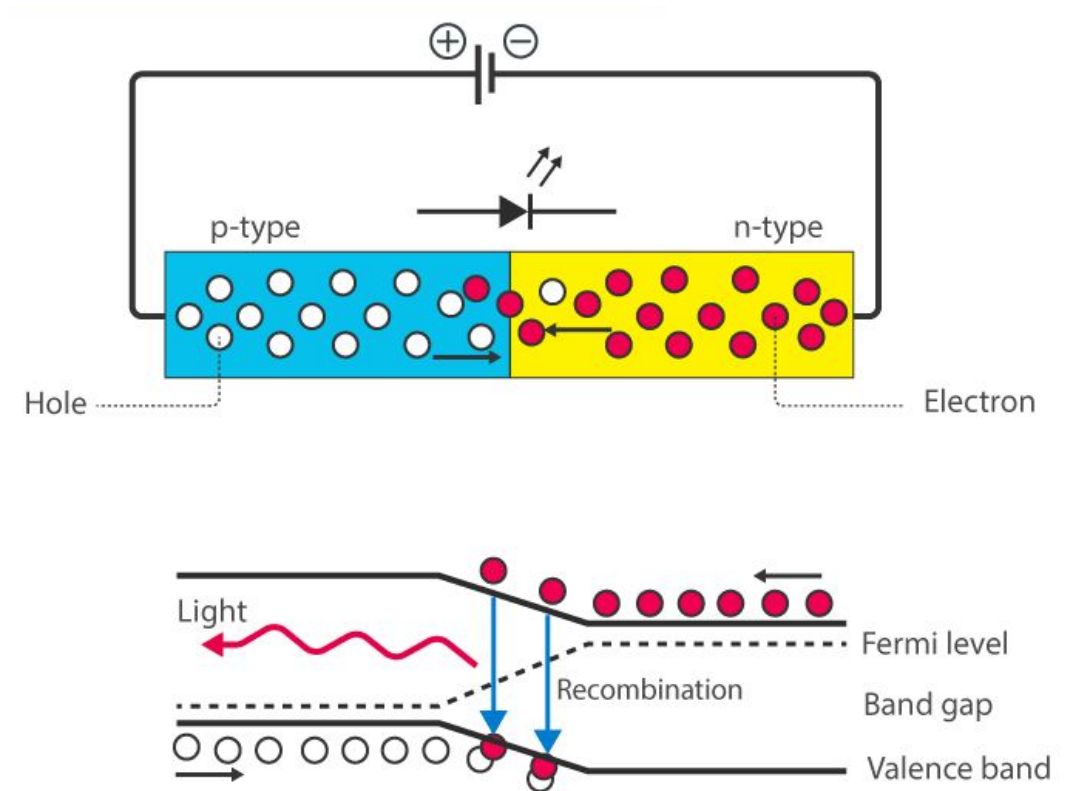

Image 03: Working principle of LED

Introduction

Gallium Arsenide(GaAs) is a semiconductor compound used in making LEDs. Doping agents are added to GaAs to give out a wide range of colors. Some of the materials used in LEDs are:

- **Aluminium Gallium Arsenide(AlGaAs) – Infrared.**
- **Gallium Arsenic Phosphide(GaAsP) – Red, Orange, Yellow.**
- **Aluminium Gallium Phosphide(AlGaP) – Green.**
- **Indium gallium nitride (InGaN) – Blue, Blue-green, near UV.**
- **Zinc Selenide(ZnSe) – blue.**

LEDs are produced in a variety of shapes and sizes. The color of the plastic lens is often the same as the actual color of light emitted, but not always. For instance, purple plastic is often used for infrared LEDs, and most blue devices have colorless housings. Modern high-power LEDs such as those used for lighting and backlighting are generally found in surface-mount technology (SMT) packages.

WAVELENGTH RANGE (NM)	COLOUR	V _F @ 20mA	MATERIAL
< 400	Ultraviolet	3.1 - 4.4	Aluminium nitride (AlN) Aluminium gallium nitride (AlGaN) Aluminium gallium indium nitride (AlGaInN)
400 - 450	Violet	2.8 - 4.0	Indium gallium nitride (InGaN)
450 - 500	Blue	2.5 - 3.7	Indium gallium nitride (InGaN) Silicon carbide (SiC)
500 - 570	Green	1.9 - 4.0	Gallium phosphide (GaP) Aluminium gallium indium phosphide (AlGaInP) Aluminium gallium phosphide (AlGaP)
570 - 590	Yellow	2.1 - 2.2	Gallium arsenide phosphide (GaAsP) Aluminium gallium indium phosphide (AlGaInP) Gallium phosphide (GaP)
590 - 610	Orange / amber	2.0 - 2.1	Gallium arsenide phosphide (GaAsP) Aluminium gallium indium phosphide (AlGaInP) Gallium phosphide (GaP)
610 - 760	Red	1.6 - 2.0	Aluminium gallium arsenide (AlGaAs) Gallium arsenide phosphide (GaAsP) Aluminium gallium indium phosphide (AlGaInP) Gallium phosphide (GaP)
> 760	Infrared	< 1.9	Gallium arsenide (GaAs) Aluminium gallium arsenide (AlGaAs)

Image 04: Characteristic of LED

Introduction

Application

LEDs are made in different packages for different applications. A single or a few LED junctions may be packed in one miniature device for use as an indicator or pilot lamp. An LED array may include controlling circuits within the same package, which may range from a simple resistor, blinking or color changing control, or an addressable controller for RGB devices. Higher-powered white-emitting devices will be mounted on heat sinks and will be used for illumination. Alphanumeric displays in dot matrix or bar formats are widely available. Special packages permit the connection of LEDs to optical fibers for high-speed data communication links.

The most common applications are:

Seven Segment Display

Normal light-emitting diodes are used in different indicator lamp displays on different variations of apparatus, such as household devices to instruments used for research purposes.

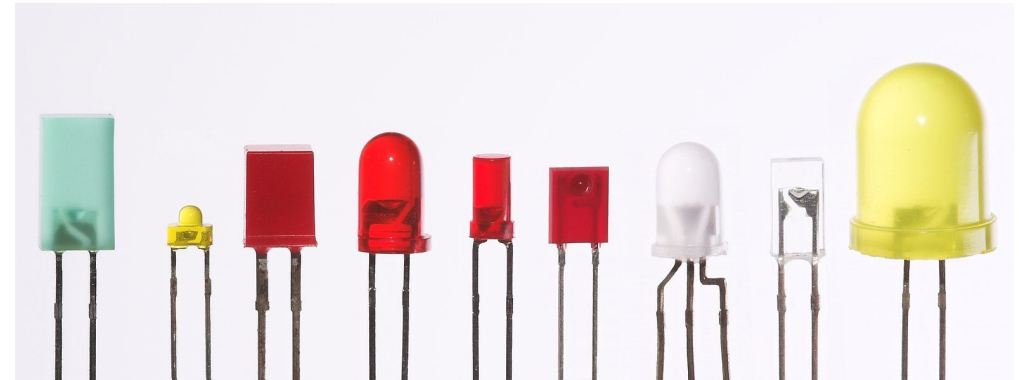

Image 05: Few variety of LED housing

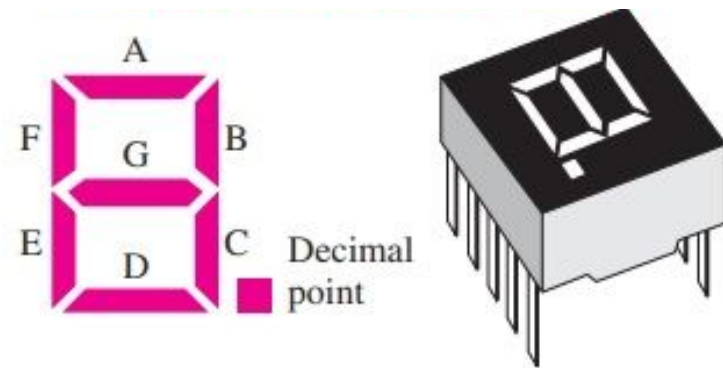

Image 06: Seven segment arrangement and typical; device

Introduction

High intensity LED

The light-emitting diodes that generate large output than standard LEDs are called high-intensity LEDs. These are used in numerous applications such as indoor and outdoor lighting, traffic signals, automobile lights, advertising signages, etc.

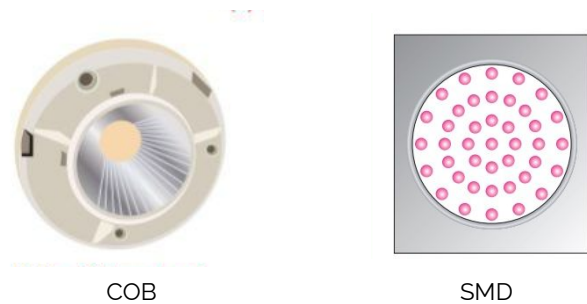

Image 07: Typical High intensity LED for Lighting purpose

LED Display

In indoor and outdoor minor signs, message boards, and large-size TVs and monitors use light-emitting diodes. These signboards can have one or more than one color or full color. Full-color screens have small groups of high-intensity green, red, and blue light-emitting diodes to make pixels. A regular screen consists of thousands of red, green, and blue or RGB color pixels. Blue-green and red are primary colors when merging in different concentrations that can be used to make any color existing in the visible range. The light production from every one of these 3 diodes can be changed autonomously by changing the forward current quantity.

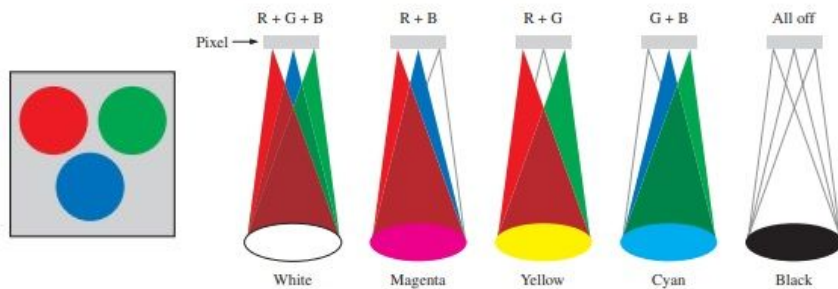

Image 08: Concept of LED Display

Introduction

Components of LED light

LED light consist of 4 component.

- **LED Chip**- Emits light
- **Driver**- Regulates the current flowing through the LED
- **Heat Sink**- Draws the heat away from the LED Chip
- **Optics**- controls the characteristics of the light output.

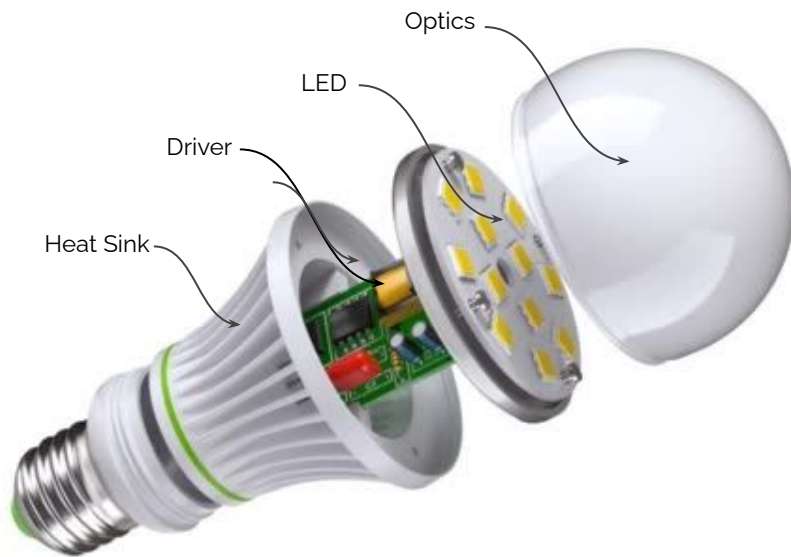

Image 09: Exploded view of LED bulb

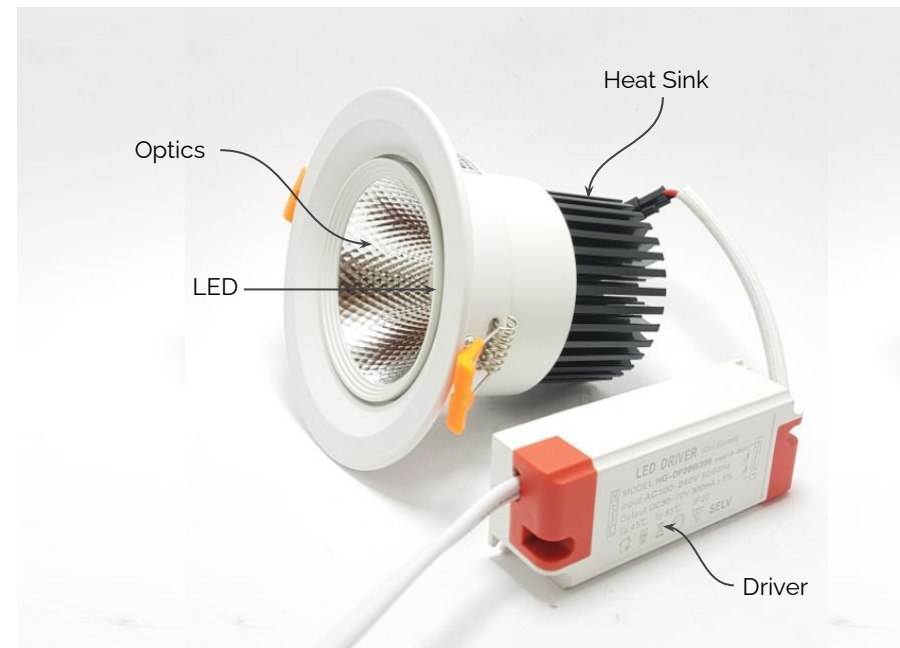

Image 10: Typical COB LED light

Colour Psychology

Color psychology is the study of hues as a determinant of human behavior. Color influences perceptions that are not obvious, such as the taste of food. Colors have qualities that can cause certain emotions in people. Colors can also enhance the effectiveness of placebos. For example, red or orange pills are generally used as stimulants.

Based on this theory, colored light helps treat physical and mental health, known as chromotherapy. According to this idea, colored light causes subtle changes in our moods and biology.

Red – The libido booster

Red is a warm color linked to the kidneys, backbone, and sense of smell. This color gives more energy and is ideal for people who are often over-tired. Active people can use red light therapy to combat muscle and joint stiffness. And finally, it also boosts sexual desires.

Yellow – The depression killer

People with a difficult digestion can treat this with yellow light. This color is associated with the stomach, liver, and intestines. People with depression could also benefit from yellow color therapy.

Blue – The bringer of peace

Blue is the counterpart of red. It can be used to lower high blood pressure or calm people down. Blue light can also help in the treatment of migraines. Your throat, ears, and mouth are linked to this color.

Green – The strength provider

Green is the color of nature. Green light therapy stimulates the creation of growth hormones and strengthens muscles, bones, and other tissues. It can also boost your body's immune system.

Purple – The Nightcap

Purple light can help you fall asleep. It also reduces emotional and mental stress. The nervous system and eyes are linked with this secondary colour. Contrary to red light, purple light decreases sexual desires.

Orange – The creativity source

Does your job demand a lot of creativity? Then orange can help. Orange stimulates the creative thought process and enables you to come up with new ideas. This color is linked to breathing. Breastfeeding women could benefit from orange light because it stimulates the production of breast milk.

Inspiration



Janet Echelman (Artist)

Installation/Sculpture

Machine woven from polytetrafluoroethylene (PTFE) and Ultra high molecular weight polyethylene (UHMWPE).

Echelman has developed aerial sculptures suspended from skyscrapers. The lightweight surfaces of these sculptures shift and ripple with air currents, an effect which are enhanced with projected light; these are often installed so the audience may interact with the sculpture, reinforcing Echelman's theme of interconnectedness.



Image 13

Ingo Maurer (Industrial Designer)

Product

Glass/Paper/ Porcelain

Ingo Maurer treated light as a poetic instrument and was also considered as the poet of light by many people. He said that in his creations, there was nothing else than simplicity and irony. He loved to take inspiration from the objects of everyday life to follow them in their authenticity and at the same time be able to add that creative note that would have only and solely his signature.



Image 14

Inspiration



Poetic Lab (Design Studio)

Product series/ Installation

The Ripple room 2014

Glass

Ripple is a moving light piece that expresses the beauty of glass and celebrates its making process. A focused beam of light projects from the smaller dome goes all the way through the mouth-blown, unevenly shaped glass dome, which gently rotates and creates shadow and light in an ever-changing moving ripple pattern, where the aesthetic goes beyond the material itself.



Carlo Bernardini (Artist)

Installation/ Sculpture

Permeable Spaces 2003

Plexiglass and Optical fibre

Carlo Bernardini produces sculptures and big environmental installations that create an architectural-minded section of light, incorporeal but visible, which is completely changing the function and structure of reality. The light creates a drawing in space, a design that will vary according to the points of view and according to the movements of the viewer, who is to live inside the work

Concepts

Concept 01

The first concept inspired by the traditional art form called Kintsugi, also known as kintsukuroi, is the Japanese art of repairing broken pottery by mending the breakage areas with lacquer dusted or mixed with powdered gold, silver, or platinum. As a philosophy, it treats breakage and repair as part of an object's history rather than something to disguise and builds on the idea that in embracing flaws and imperfections, you can create an even stronger, more beautiful piece of art.

While roaming around the campus for inspiration, this idea stuck while looking at the construction site where many damaged brick/concrete blocks were lying around. These blocks might be damaged during transportation or handling at the site and are deemed unusable. As an architect, I understand the efforts that go into making one of these brick blocks, especially if they are handmade. And all that efforts are thrown aside when they find a flaw. I can't overcome the uncanny similarity with humans in this capitalistic world where young ones are trained to become particularly mindless individuals to fulfill their only job.

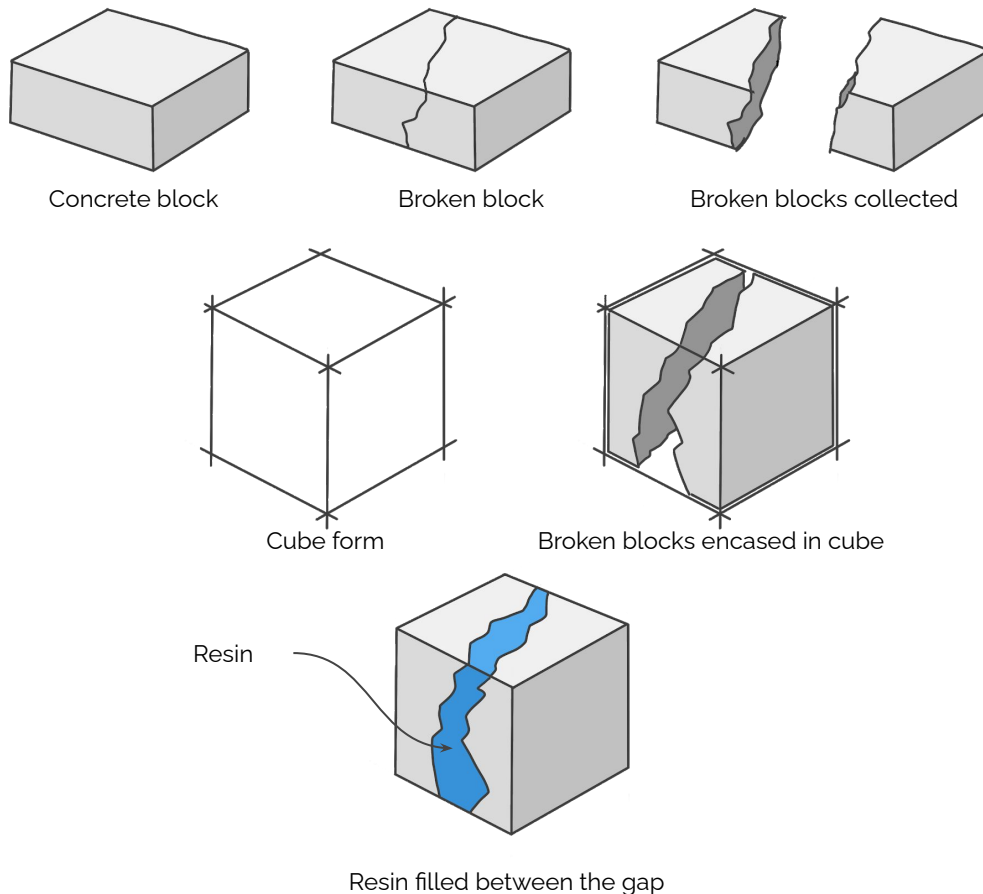

Concepts

When they are unable to show their worth, they are deemed unusable and considered failures in society. The idea is to get these broken individuals/ blocks together and repurpose them to be more beautiful and inspiring by allowing them to become much more than a block.

Design: The blocks from the construction site would be collected and converted into a perfect cube (A metaphor of societal perfection) using a translucent resin between them. A light-emitting from below indicates the new life of these blocks born after repurposing. Colors added to the resin differentiate each other and will induce different emotions among the users.

Product: *Table Lamp, Mood lamp, Decorative House light.*

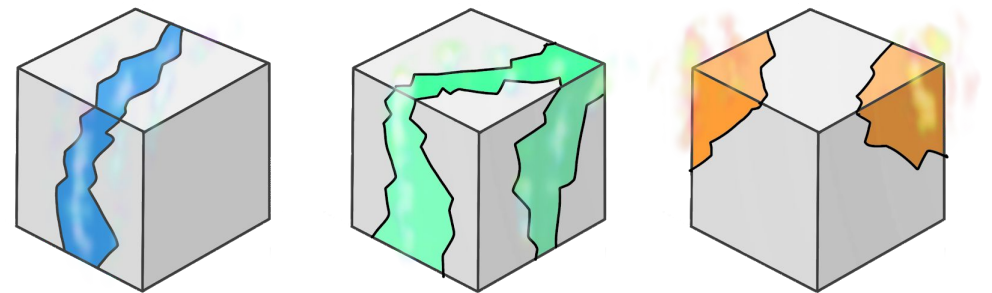

Different colour resin glows due to the LED light at bottom

Concepts

Concept 02

This concept is also about life, inspired by a visual metaphor of a budding flower. It is significant because there is a strong parallel between us and a bud. As buds open and unfurl itself to show its many layers and depth of beauty. As individuals, we also grow and learn, genuinely learning, our minds and selves begin to bloom and unfurl just as a bud, starting small and simple, then increasing in breadth, complexity, and beauty as we pursue and increase our potential.

Design: A spiraling down strip is interlaced with LED light on the inner surface. At the initial bud position or compressed from, the light from the design would be low as the strip surfaces overlap and block the light from inside, indicating the conserving nature of a young being filled with hidden potential. On opening up step by step, the overlap would reduce, and the intensity of light increases and shows its hidden sculptural form. The design's dynamic nature also makes the product more interactive and involves users physically with the product.

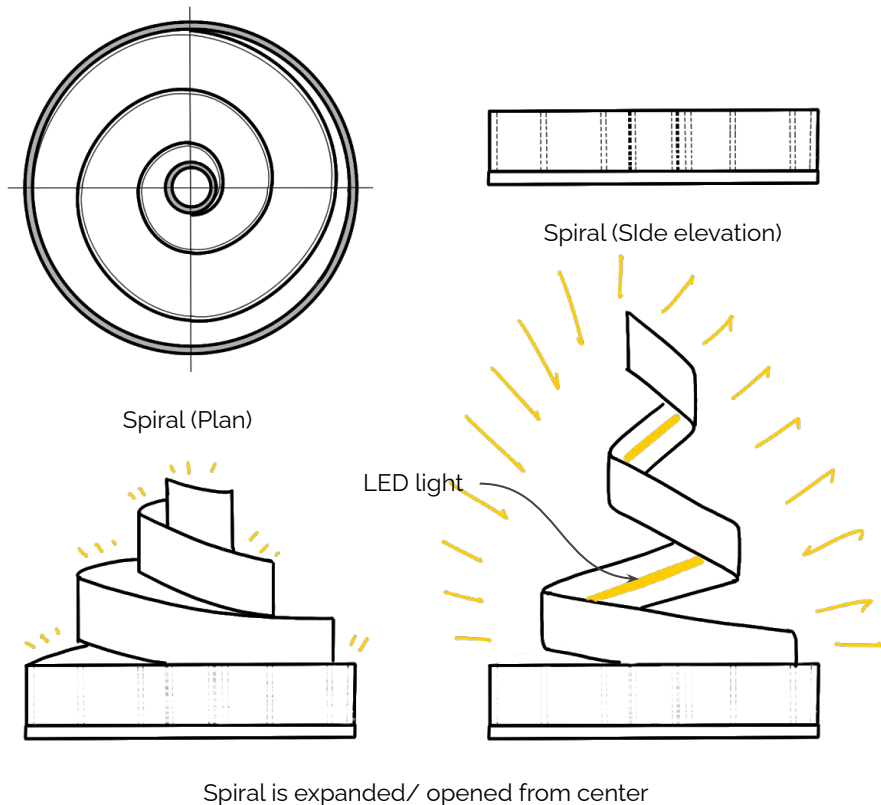

Product:

Chandelier/Hanging light, Table lamp, Decorative lamp.

Art Installation, Street light, Landscape light for parks and any recreational areas (Scaled up)

Concepts

Concept 03

The third concept is derived from the motion of the leaf falling from the tree. The slow-mo type swirl falling of the leaf provokes a calming effect in the watchers. It also generates the feeling of peace and tranquility while watching it. The idea is to induce these emotions among the users through a product.

Design: The Product consists of 2-3 different standing light sculpture which replicates the swirling action into the form with LED incorporated into the structure. The light is covered with acrylic pieces that run along the body to diffuse light. The 3 of them will have a different intensity of swirl, indicating uniqueness in each of them. The product's form with light induces a motion effect in the stationary object as perceived by the users.

Product: Standing lamp, Ceiling lamp, Decorative mood lamp.

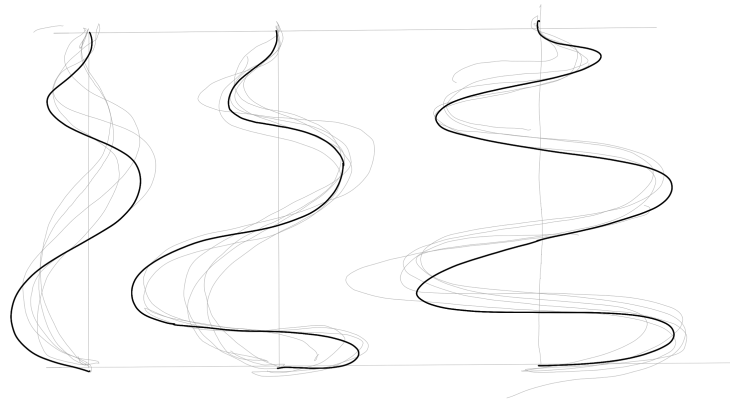

Different swirl path of falling leaf from trees

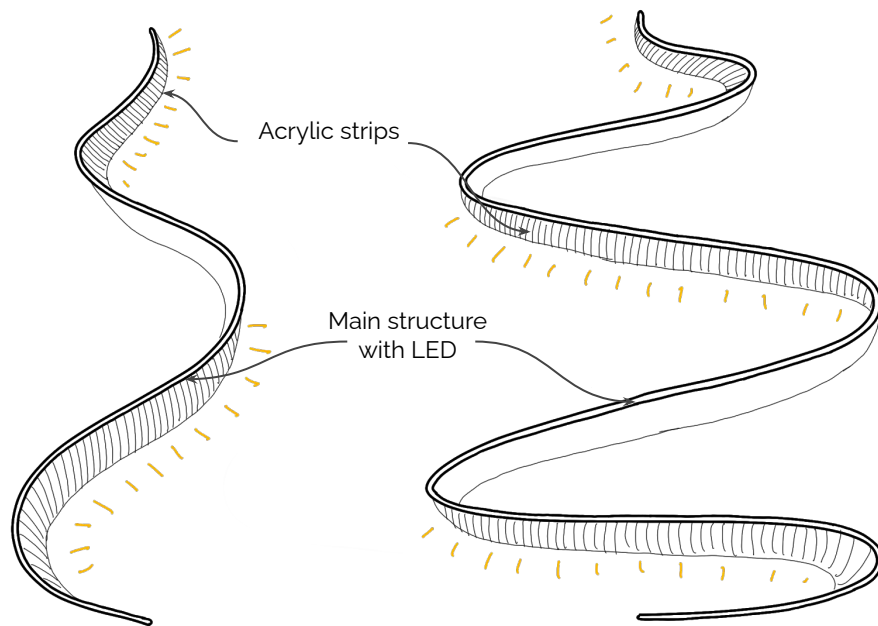

Lamp with main body replication the swirl path and acrylic strips as diffusers.

Concepts

Concept 04

The fourth concept was an evolution of one of my previous works in which a laser-etched surface on the acrylic sheet is used to disperse light produce by LED fixed below. The multiple layers of acrylic are stacked to create a 3 Dimensional image trapped inside a cube. The idea is to create a subtle motion inside the 3D image to create a dynamic light.

Design: The alternate layer of acrylic stacked is connected with one light strip and has one type of 3D image, whereas the other alternate one has a slightly different image, which creates a sense of motion when lights are used in a sequence. Similarly, all sheets can have a frame of a defined motion which will create an illusion of an object trapped inside the cube.

Product: Table lamp, Decorative mood lamp.

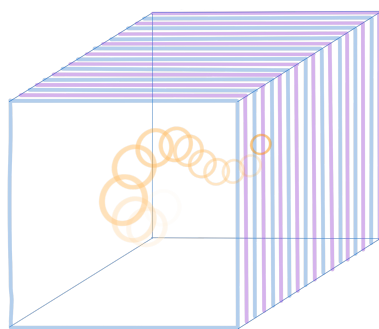

Ortho

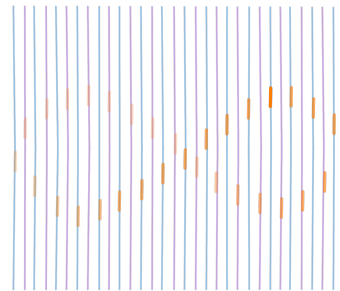

Side View

Each slide with one frame of defined movement to incorporate motion in light.

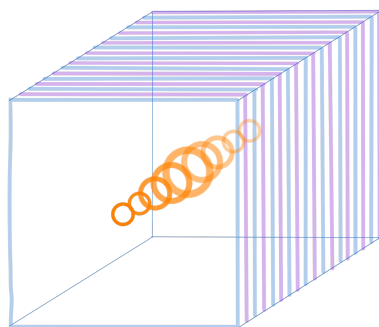

3d Image 01

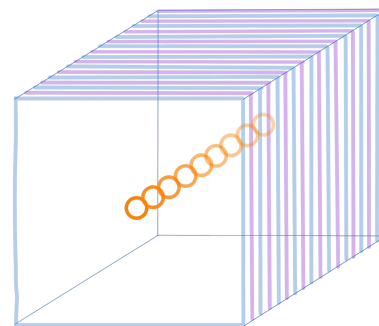

3d Image 02

Alternate slides with slight different 3D image to create subtle motion in light.

Exploration

Concept 02 is selected to explore further based on the uniqueness and originality of the idea alongside the feasibility of making a physical model during the restrictive and unavailability of resources due to the ongoing pandemic.

A prototype is created to explore different possible materials and details to design a practical product. The following were the steps involved in the explorations.

Firstly, styrene was used as a material for the spiral.

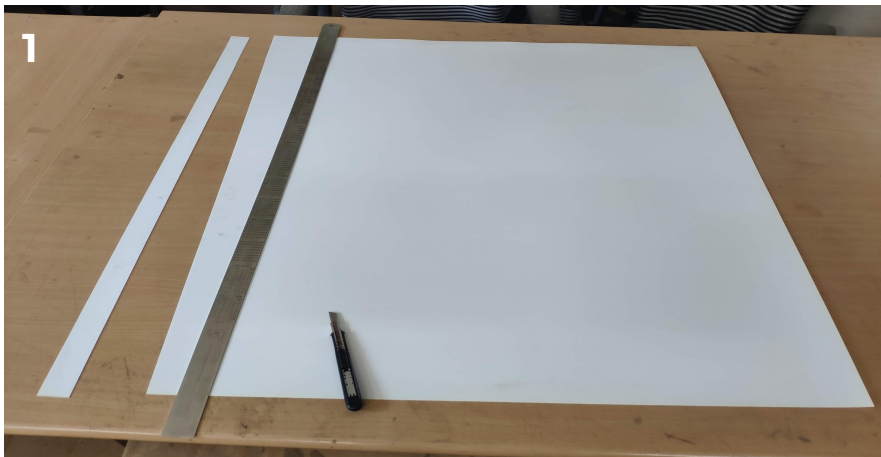

A strip of 25mm wide styrene is cut from the 0.5mm thick sheet.



The strip is wrapped around a cylindrical object and hot air is blown over it to retain the shape.

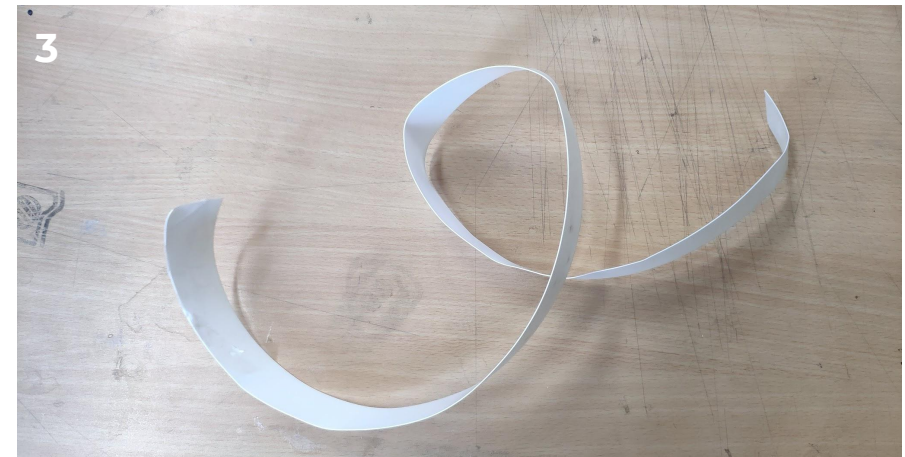

Due to thickness the the strip deformed and didn't retain the shape as expected.

Exploration



4 Another styrene strip is fixed on two rings, acting as a spiral's inner and outer end, using chloroform.



6 The spiral shape was formed, but it was not uniform because of its tensile strength. The surfaces tend to stack at one side of the circle.



5 Rings are connected using a small wooden rod through them at the center.

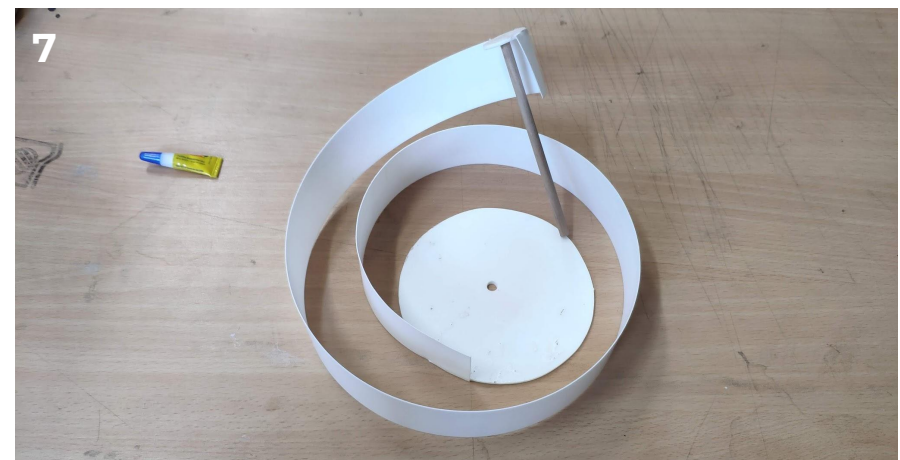

7 After applying heat, the styrene did not retained its spiral form.

Exploration

As styrene didn't work out, an aluminium sheet is taken to create the main spiral of the final concept.

As aluminium is also a good conductor of heat, it will also act as a heat sink for the LEDs.

The initial steps were repeated as before to create the spiral out of aluminium strip and further explored with an LED strip attached to it.

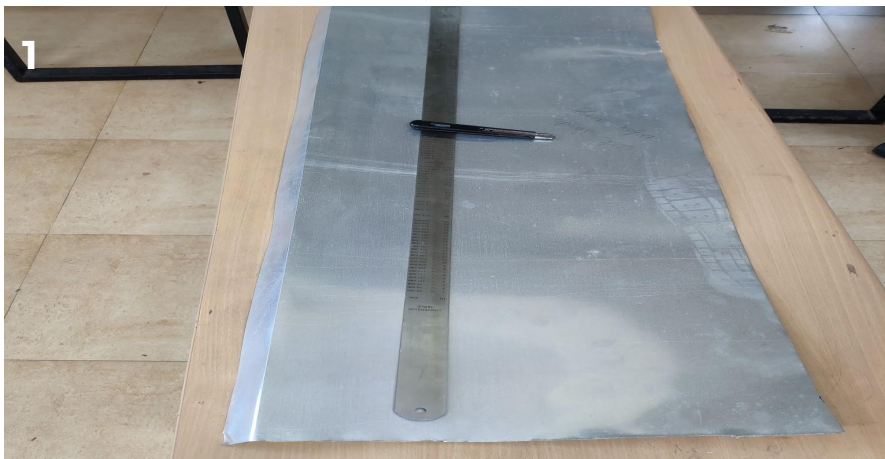

A strip of 25mm wide Aluminium is cut from the 0.5mm thick sheet.



The strip is wrapped around a cylindrical object and taken out to create a spiral surface.



The LED strip light is fixed to the inner surface of the spiral and then tested.

Exploration

Opening and closing of the product is tested to see the material's flexibility and to check the case made in the concept regarding light intensity.



When in the closed stage, the surfaces block the light from spreading sideways and create a unidirectional lamp like a spotlight.



When expanded, the overlapping surface area reduces due to the form, and the light starts to spread around the object like a typical table lamp.

Exploration

After POC, I have explored a mechanism for the movement between the product's closed and expanded stage.

The initial idea of having a handle to control the expansion and light intensity is tested out.



1 A back cover is added to direct the light in one direction.



2 An aluminium rod is added, connected to the inner edge through the back cover.



3 Aluminium rod is moved up and down to change the stage of the product from closed to expanded.

Exploration

The mechanism of moving aluminium rod up and down to change the product's stage from closed to expanded while controlling the intensity of the light was seemed to work.



Closed stage



Expanded stage

Product ideations

After exploration, another set of ideations are done to integrate the mechanism and learnings from previous sections into a full-fledged product design.

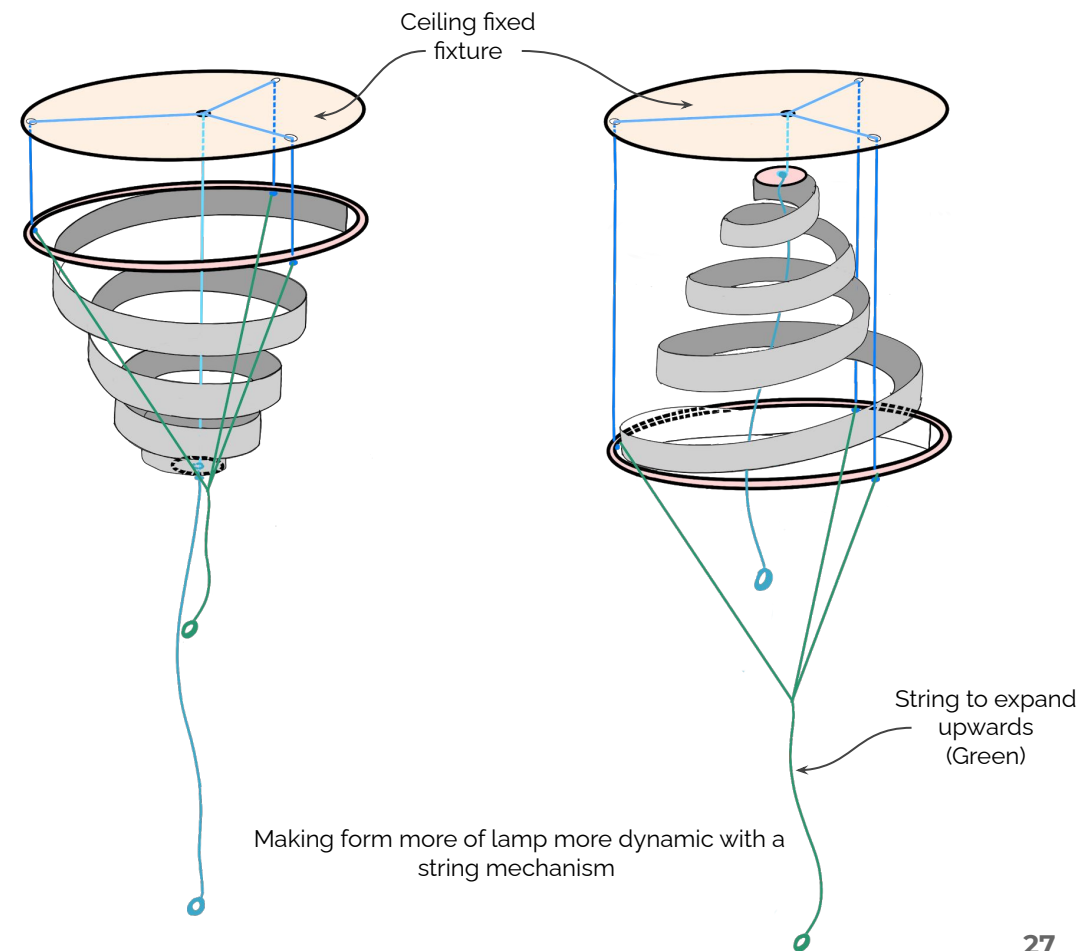
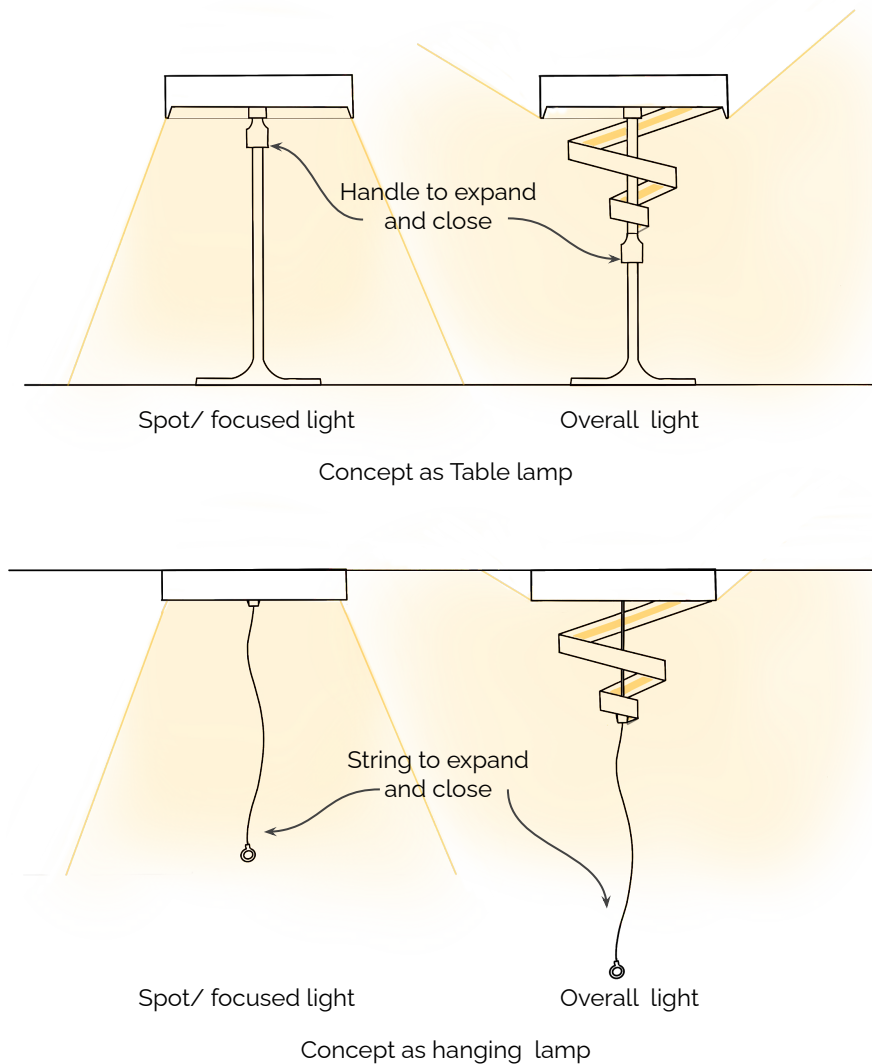

Exploration

A hanging lamp model is further developed to explore the lamp's mechanism dynamics and usability as a product.

Another model is made with refined details and techniques to create a seamless and clean spiral. That is tested to try out the mechanism designed.



1 A stencil is cut to create a more defined spiral form.



2 A strip 25 mm wide stainless steel is inserted inside the stencil to create a spiral shape.



3 A ring is added around to contain the spiral shape.

Exploration

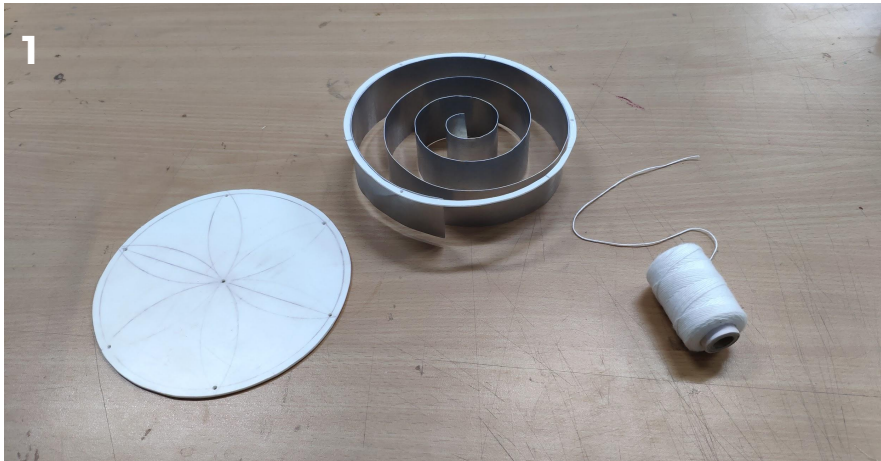

1 A styrene sheet is used as a ceiling mount panel and thread for the string mechanism.



3 String from the circumference is taken back through the central hole to create a continuous connection for the mechanism.

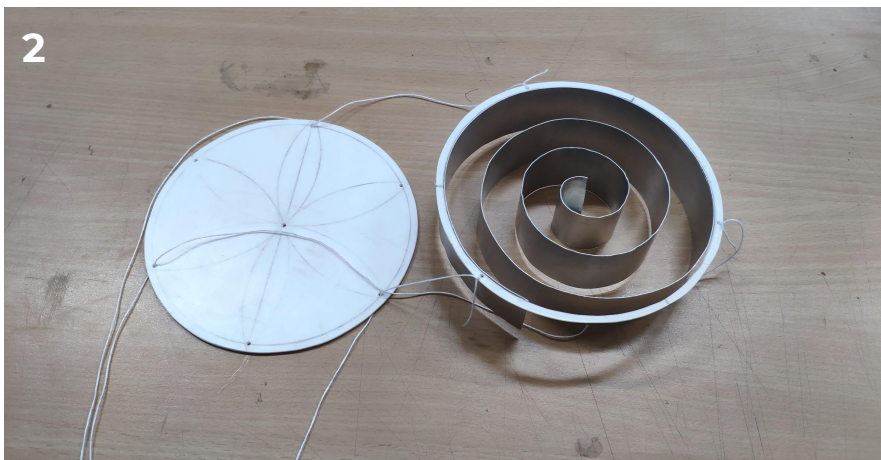

2 Holes are made on the ring and the ceiling mount panel for passing string.

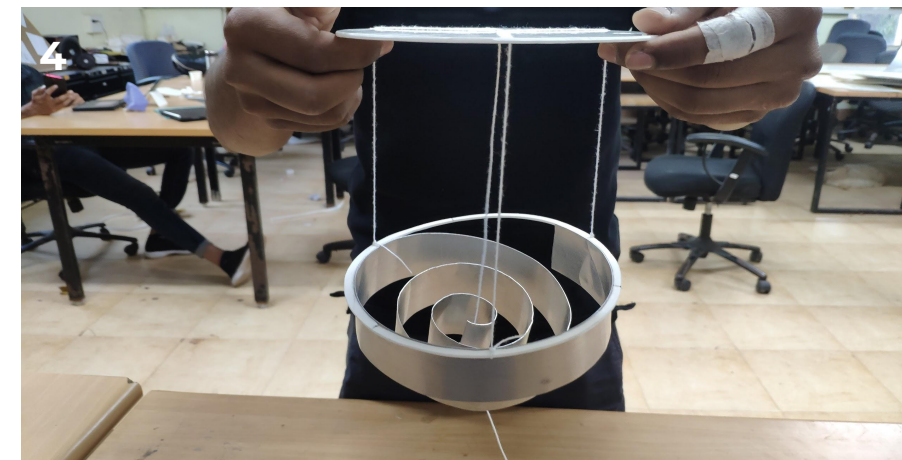

4 The lamp is suspended at a desired height from the ceiling panel.

Exploration

The mechanism is tested by pulling the two different strings to expand the light upwards and downwards.

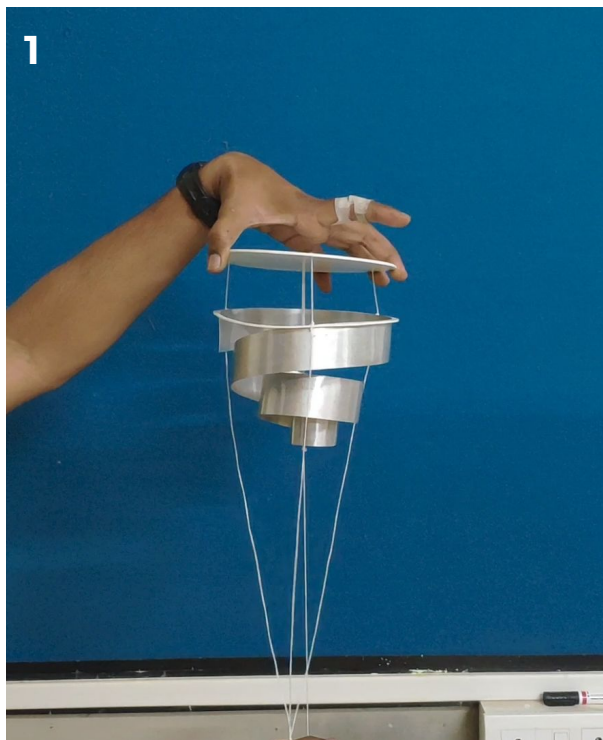

String coming from center is pulled to expand the lamp downwards.

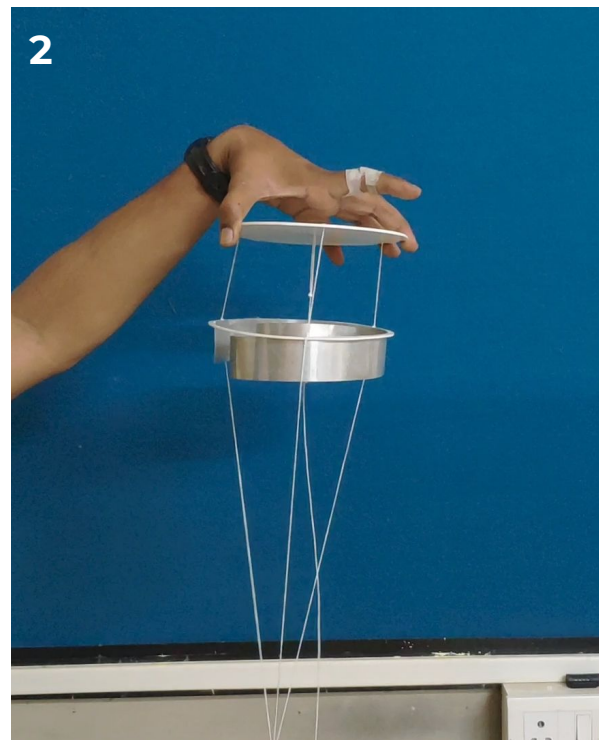

When force released, due to elastic nature of steel it returns to its original position.

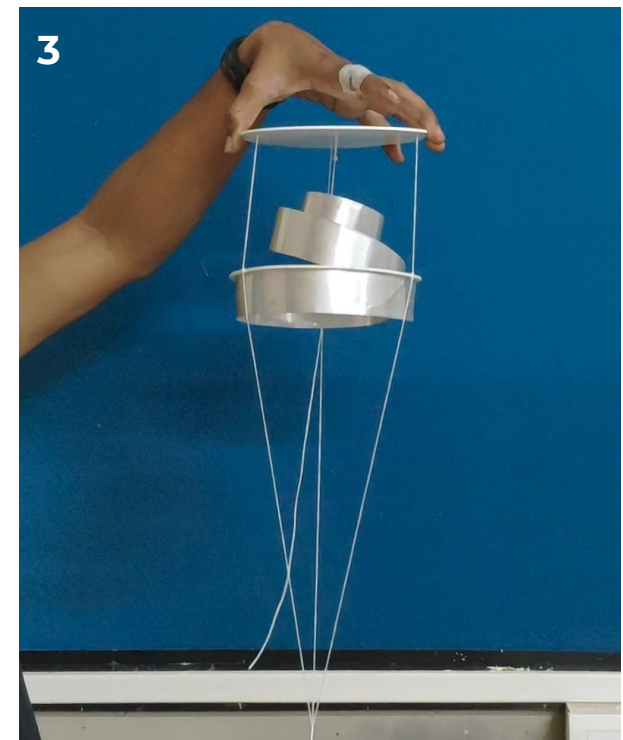

Combined string from the periphery is pulled to expand the lamp upwards.

Final Exploration

Even though the mechanism worked, it was not very intuitive to use, and strings around the light were making it messy and visual clutter to appreciate the lamp itself.

A more straightforward and simple approach is taken in the final exploration where i intended to automate the mechanism using a small DC motor and a reversible gearbox. Automating the mechanism makes the lamp, a dynamic sculpture that constantly changes its form at a gradual pace.

The main spiral is fixed on the ceiling with four metal rods to create a hanging-type lamp. The spiral is made from aluminium sheet with a string attached to its center, connecting the mechanism. The other end of the string is connected to the heavy metal ball/object so that when the motor unwinds the string, the heavy metal ball makes sure the force is applied downwards.

The LED strip light is fixed on the inner face of the metal strip. The adaptor for the LED light and the motor with the gearbox are fixed above the ceiling (Inside the false ceiling). The motor has a programmed distance to wind and unwinds respectively to create a dynamic moving lamp.

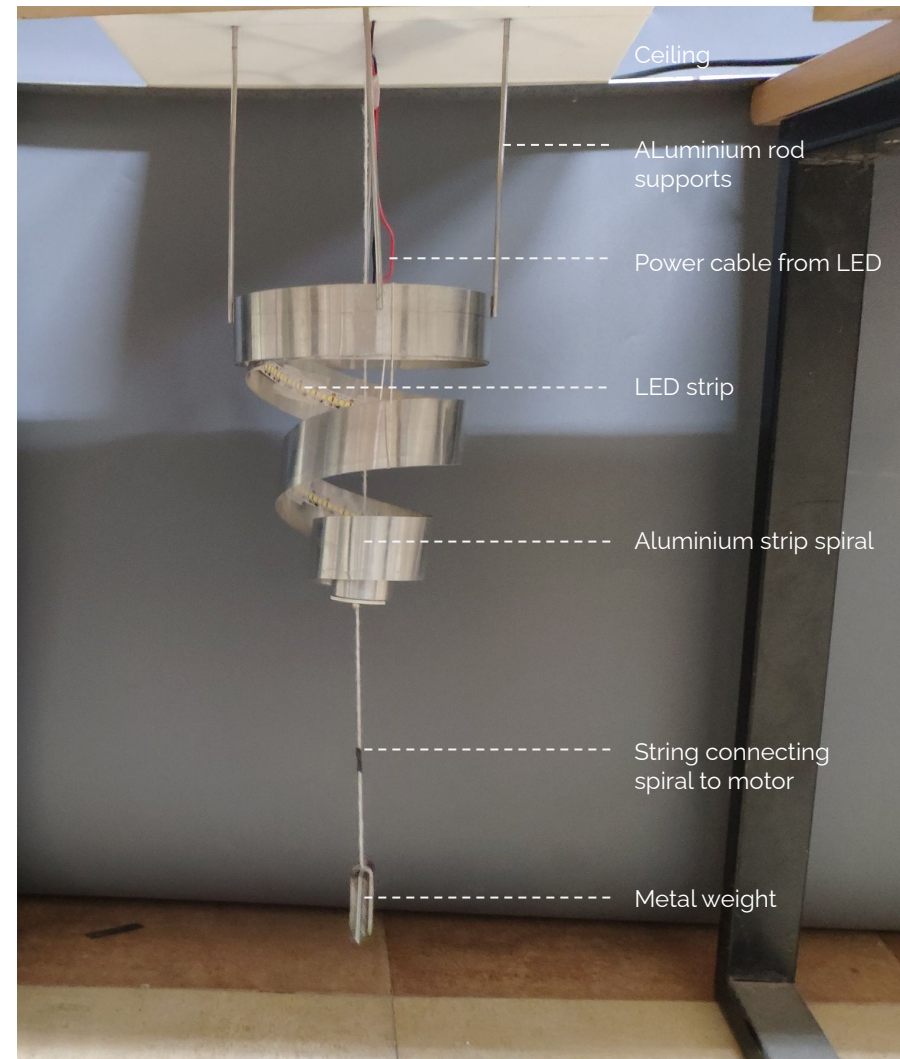

Final Exploration

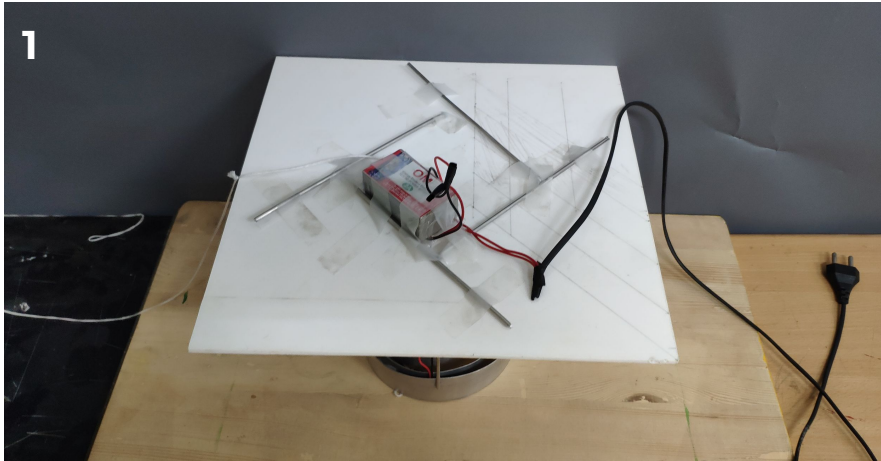

1
Ceiling panel will have adapter for the LEDs and the motor with gearbox (intended)

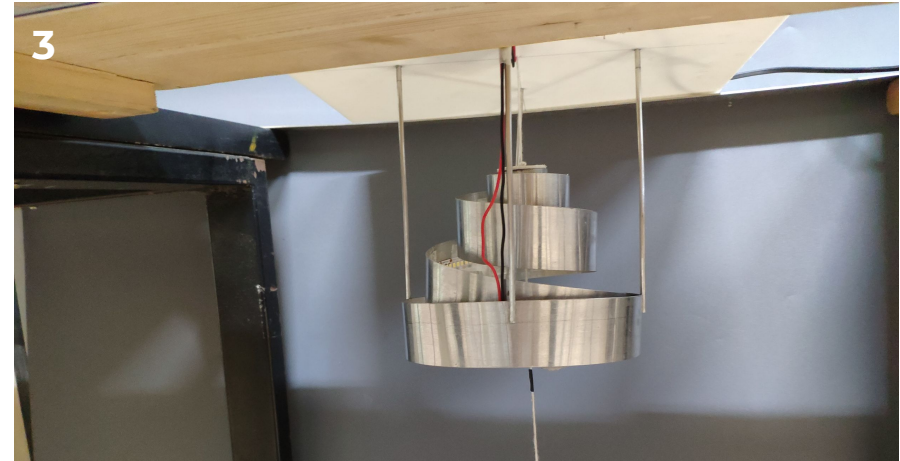

3
Support member is supposed to be hollow to carry the electrical wire inside till the ceiling.

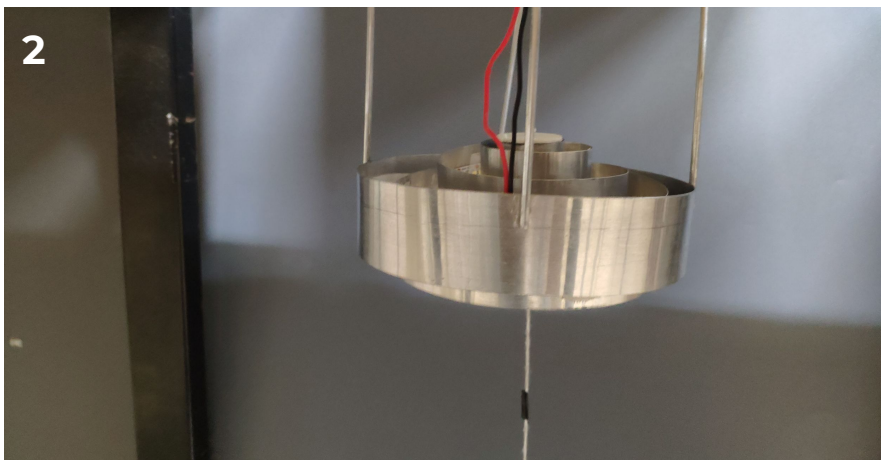

2
Four metal support member from the ceiling panel is fixed on the outer rim of the lamp.

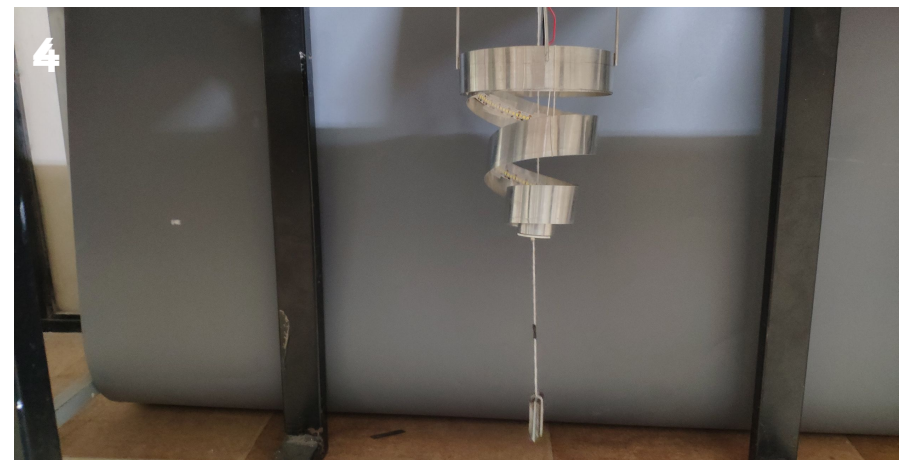

4
A string from the ceiling passes through the center of lamp connecting the tip of the metal strip and hanging with a weight attached at the other end.

Final Exploration

Due to time constraint and lack of resources the prototype was made without the motor and gearbox. The action was replicated by pulling string manually.

[Click here](#) to see the video.

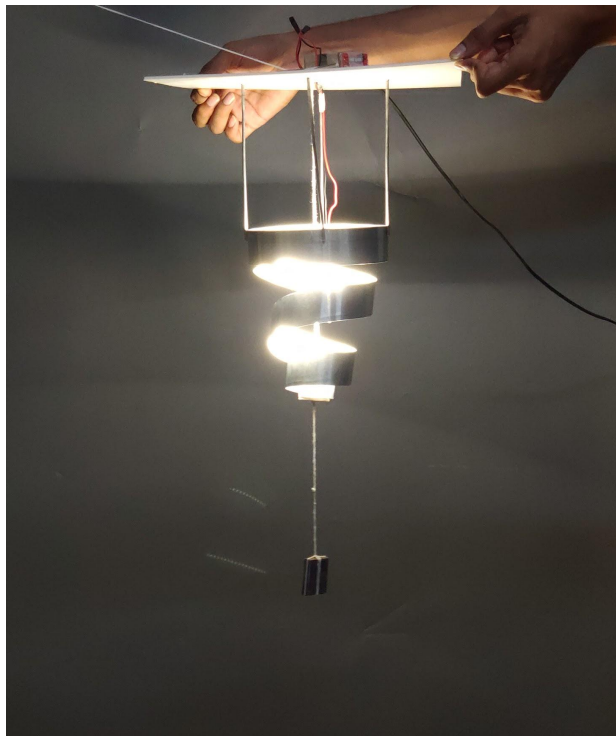

Expanded downwards

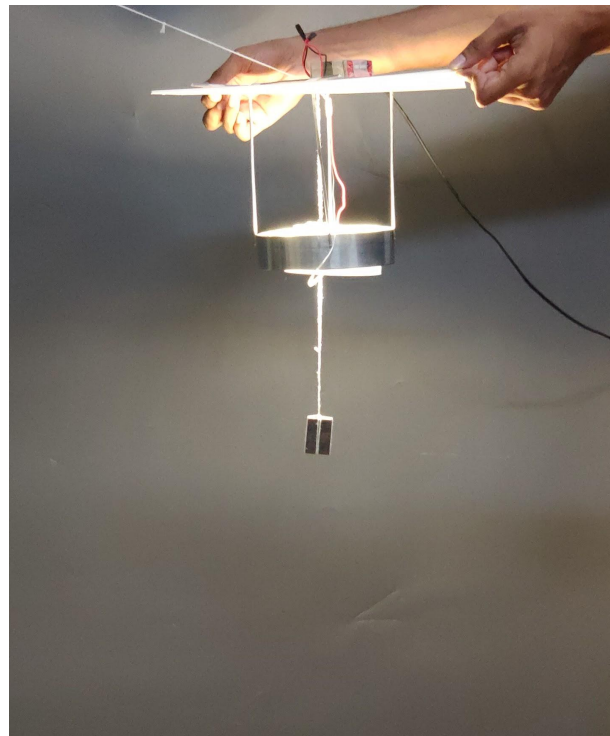

Neutral / Default position

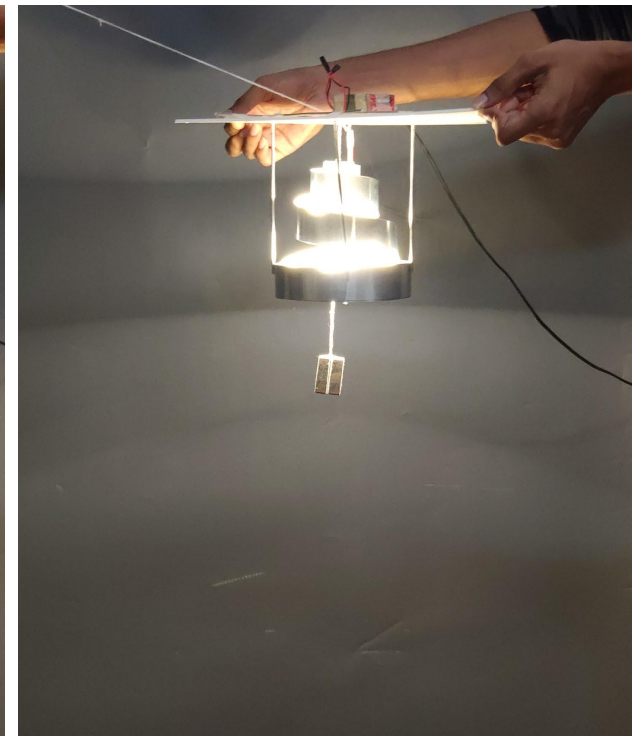

Expanded upwards.

Final Exploration

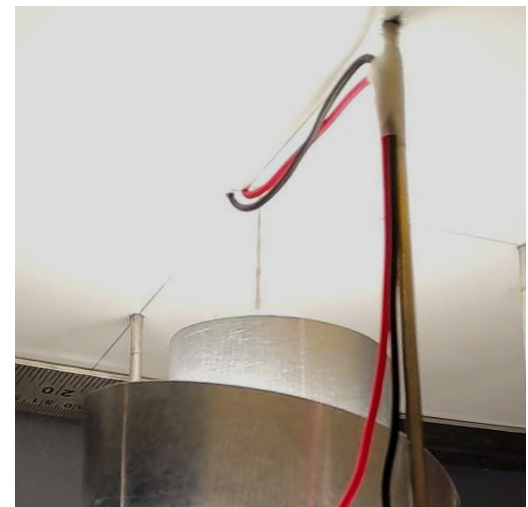
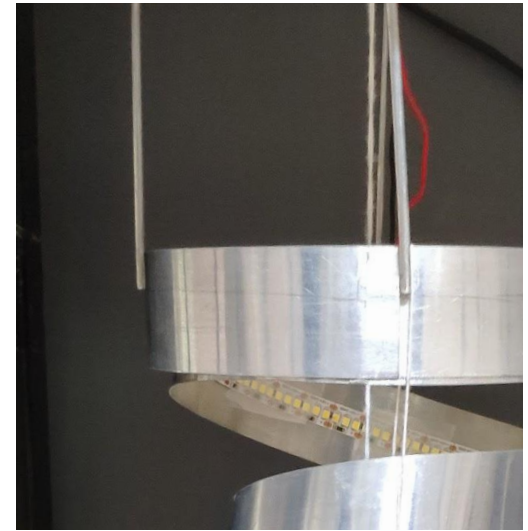
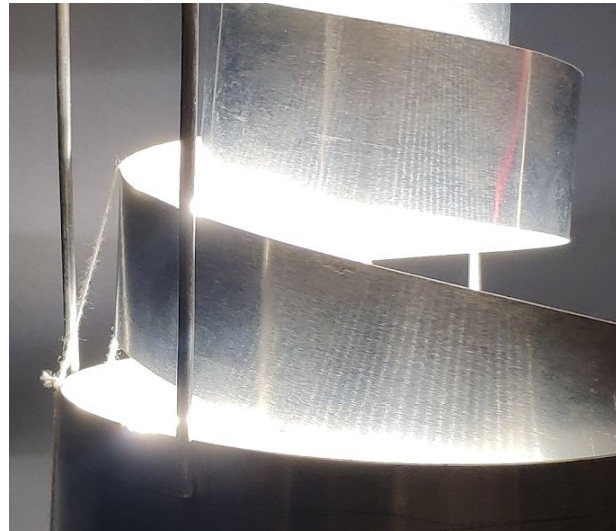

Final product visualisation

The final product is reimagined as a luxury lighting solution for large interior spaces from shopping malls to large hotel atriums. The scale, proportions and details are further refined for the finished product.

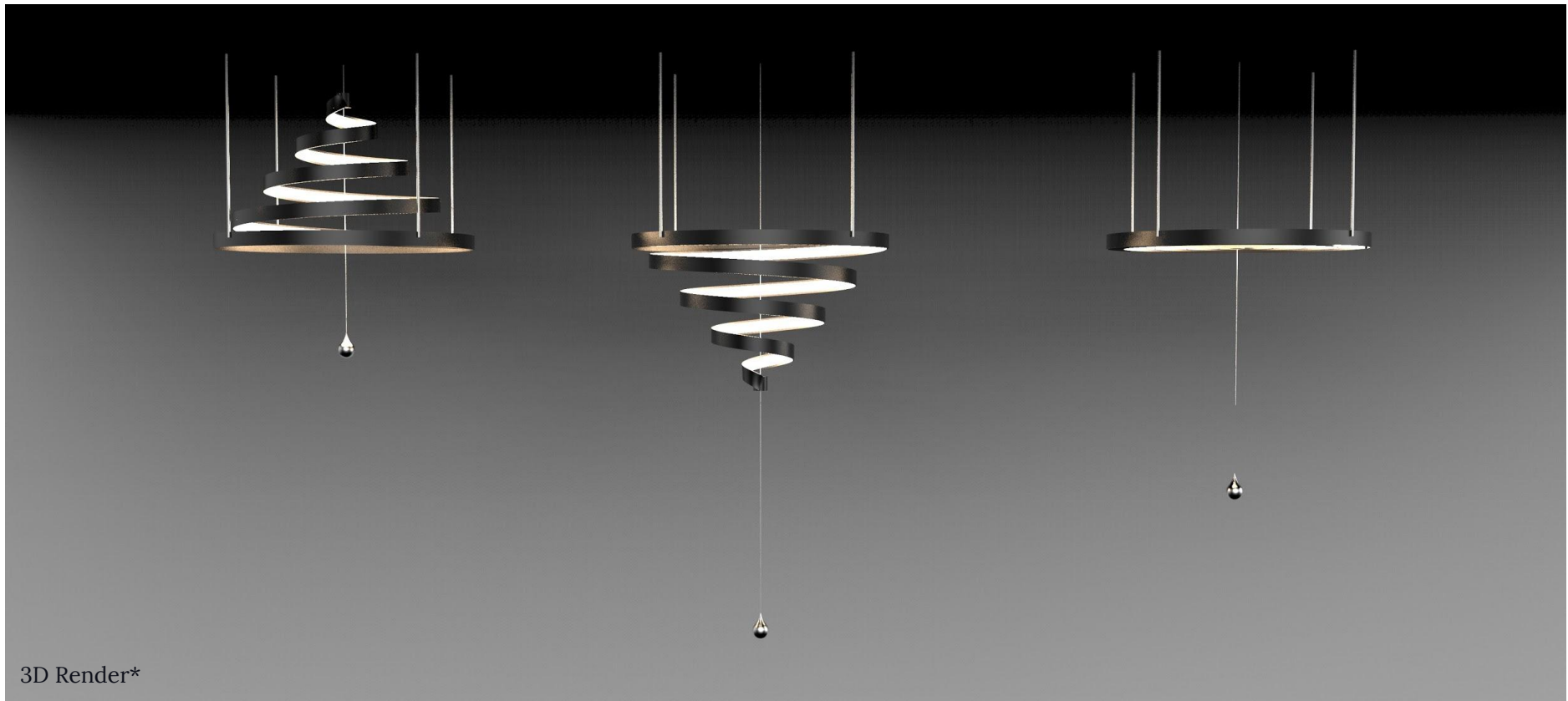

Final product visualisation

The dynamic changing form make it more interactive and striking to the audience.



Expanded downwards

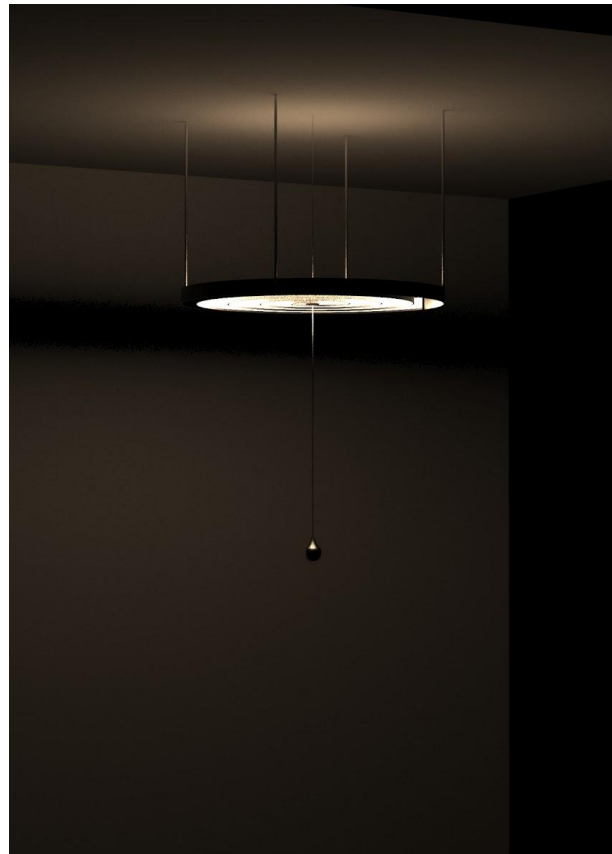

Default



Expanded upwards

Final product visualisation



The composition of multiple lights with a separately timed mechanism creates a dynamic visual delight.

Final product visualisation



Different compositions can be played out by the users with multiple lights as per need.

Conclusion

The budding flower concept was taken forward with the help of an LED light strip, Where the flexibility of the LED strip was exploited to create a shape-changing dynamic lamp.

Several models are made to understand the physical constraints of the concept and the practicality of developing a product out of it. Even though the mechanism and technical constraints were resolved, the availability of materials and other resource constraints limited the material explorations due to pandemic restriction.

The aluminum sheet may have helped determine the mechanism; it has several issues to be considered as a primary material for the spiral. It is observed that the thickness of the material defines the size of the lamp, and the spiral opens up unevenly when due to the uneven distribution of self-weight, which spoils the beauty of the whole concept.

Future work

Plastic alternatives like PP, TPE, or SBC, which can be strong, flexible, and compatible with injection-molded, can be used for a spiral body to achieve a more defined form.

Varying thickness in the spiral can be used in a mold to evenly distribute the self-weight to get uniform opening up of the spiral.

3D printing with flexible filament can be explored as an option for the spiral body.